

USER MANUAL

6.7 cu. ft. FRONT-LOAD DRYER

ETDE6727CW (Electric) | ETDG6727CW (Gas)

Product may vary. Please refer to the actual product.

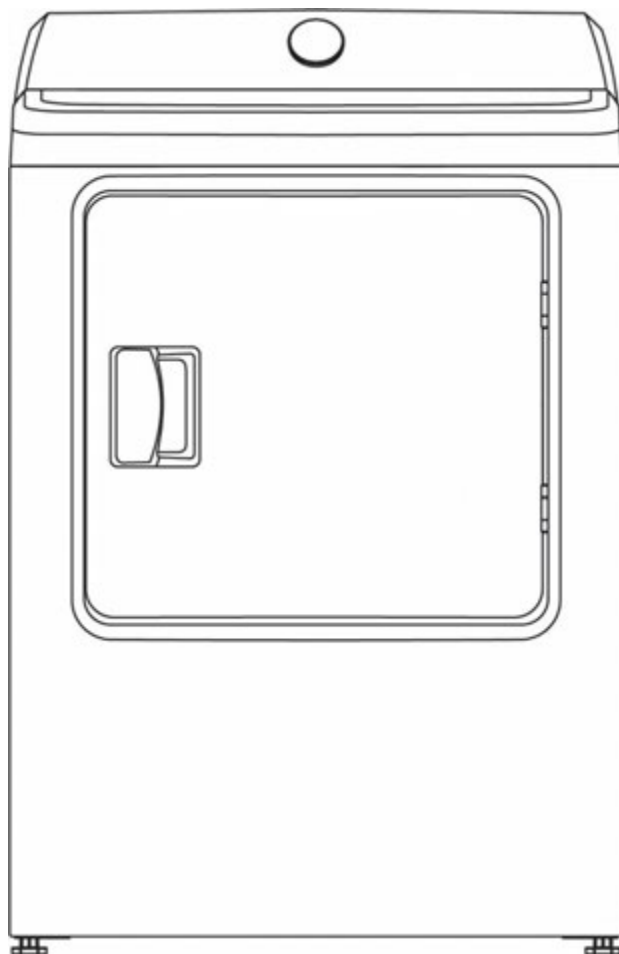



CONTENTS

REGISTER YOUR DRYER	3
GETTING TO KNOW YOUR DRYER	4
WHAT IS INCLUDED?	4
TOOLS YOU'LL NEED.....	4
FRONT VIEW.....	4
BACK VIEW.....	5
CONTROL PANEL	6
PREPARING FOR INSTALLATION.....	7
CHECKING INSTALLATION REQUIREMENTS	7
CHANGING THE VENT LOCATION	14
REVERSING THE DOOR.....	15
SETTING UP YOUR DRYER	17
UNPACKING THE DRYER.....	17
POSITIONING THE DRYER.....	17
CONNECTING THE EXHAUST SYSTEM.....	17
CONNECTING THE GAS LINE (GAS MODELS ONLY).....	18
CONNECTING THE ELECTRICAL WIRING.....	19
LEVELING THE DRYER	21
POWERING THE DRYER	21
USING YOUR DRYER	22
DRYING A LOAD OF LAUNDRY	22
SETTING THE CONTROL LOCK.....	23
UNDERSTANDING CYCLES AND OPTIONS.....	24
DRYING TIPS.....	25
CARING FOR FABRICS.....	26
CLEANING THE DRYER	27
CLEANING THE CONTROL PANEL.....	27
CLEANING THE INNER DRUM	27
CLEANING THE EXTERIOR	27
CLEANING THE EXHAUST SYSTEM	27
SAFETY AND PRECAUTIONS	28
SPECIFICATIONS.....	31
TROUBLESHOOTING.....	31

ERROR CODES 33

CUSTOMER SUPPORT..... 33

LEGAL NOTICES.....34

WARRANTY34

REGISTER YOUR DRYER

Thank you for purchasing the Element 6.7 cu. ft. Front-Load Dryer. If you have questions about your dryer, our customer support team is ready to help:

- **Online chat:** <https://elementelectronics.com/appliances>
- **Phone:** 888-842-3577
- **Email:** customerservice@elementelectronics.com

To register your dryer, go to <https://elementelectronics.com/registration/>, fill out the Product Registration form, and upload a picture of you receipt. Your serial number is located on the rating label on the front of your dryer when you open the door.

Use the space below to record information about your dryer and keep your original purchase receipt for future reference. You'll need this information to receive warranty service.



6.7 cu. ft. Dryer

Model Number: _____

Serial Number: _____
(located on the rating label)

Date of Purchase: _____

Keep this information and
your original purchase receipt
to receive warranty service.

GETTING TO KNOW YOUR DRYER

WHAT IS INCLUDED?

- 6.7 cu. ft. Dryer
- *User Manual*

TOOLS YOU'LL NEED



Adjustable wrench
(opens to 1 in. (25 mm))



Flathead screwdriver



Phillips screwdriver



Aluminum tape



Cutting knife

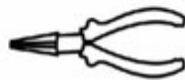

Pliers



Level



Pipe wrench
(gas dryer only)

FRONT VIEW

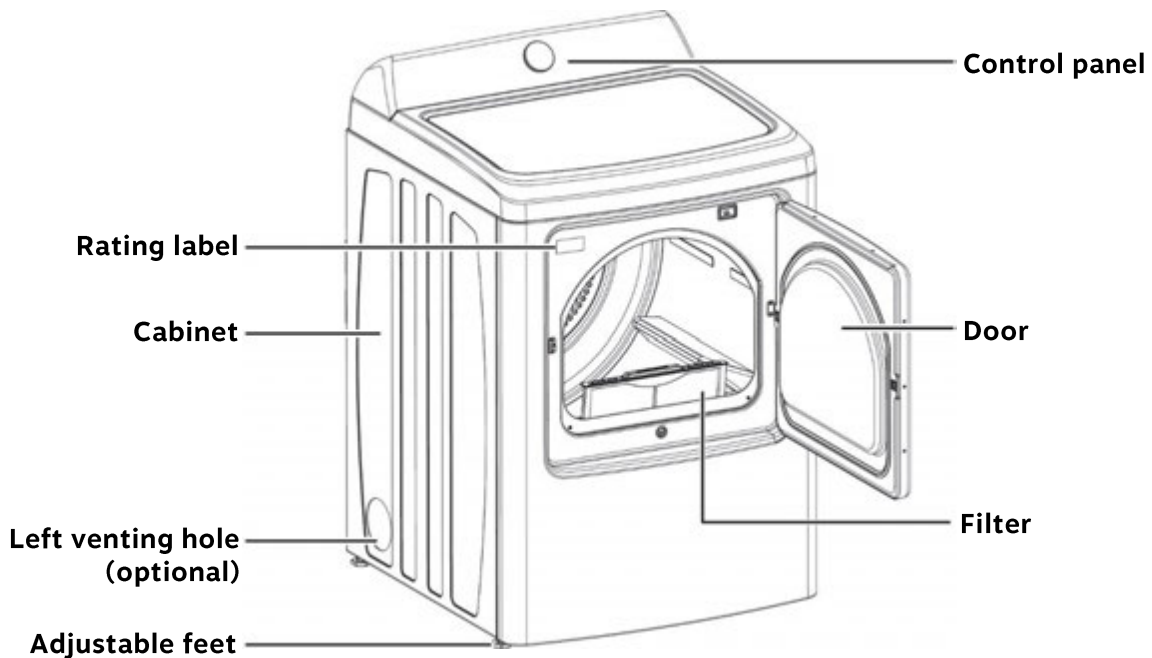

BACK VIEW

ELECTRIC DRYER

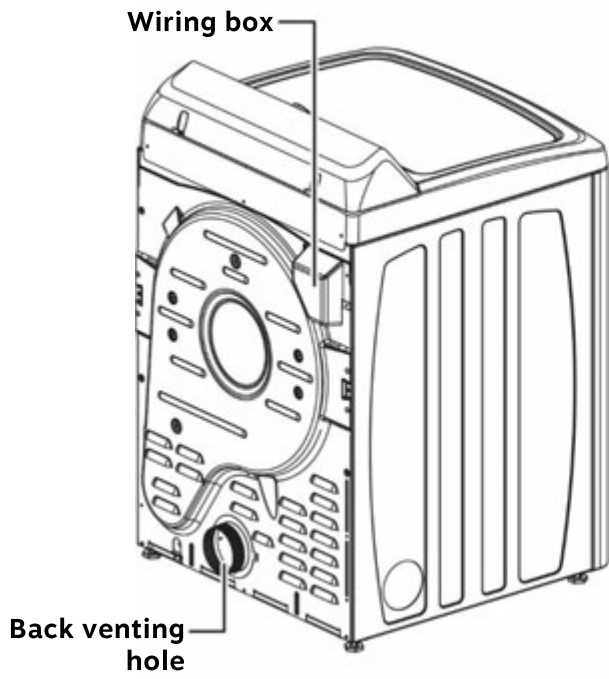

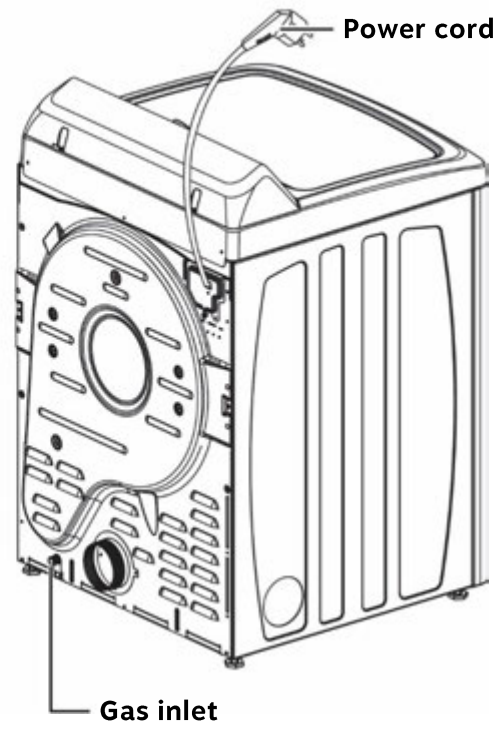

GAS DRYER

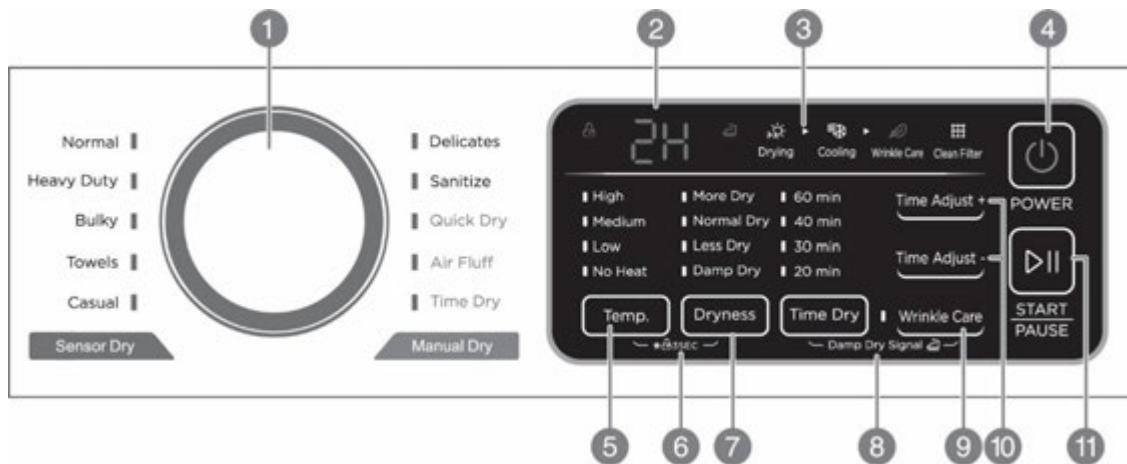

CONTROL PANEL



#	FUNCTION	DESCRIPTION
1	Cycle Selector	<p>Select your desired cycle for the type of load. The cycle you select determines the heat control for the cycle.</p> <ul style="list-style-type: none"> The Normal, Heavy Duty, Bulky, Towels, Casual, Delicates, and Sanitize cycles are Sensor Dry cycles. The Quick Dry, Air Fluff, and Time Dry are Manual Dry cycles.
2	Digital Display	<ul style="list-style-type: none"> Displays the time while you are pressing the Time Adjust + / Time Adjust - to set the time for the Quick Dry, Time Dry, or Air Fluff cycle. Displays the remaining cycle time while your dryer is running.
3	Cycle Status Display	<p>The indicators light up to show which processes will be used during the drying cycle. When the cycle reaches each process, the indicator flashes to show where you are in the cycle.</p>
4	Power	<p>Press to turn your dryer on or off. If you do not press any buttons within 10 minutes, the dryer automatically turns off.</p>
5	Temperature	<p>Press the button to select the drying temperature.</p> <ul style="list-style-type: none"> High: For sturdy cottons or items labeled Tumble Dry. Medium: For permanent press, synthetics, lightweight cottons, or items labeled Tumble Dry Medium. Low: For lower heat than Medium to dry synthetic or washable knit fabrics. No Heat: Provides just the air cycle without any heat.

#	FUNCTION	DESCRIPTION
6	Control Lock	Press and hold Temp. and Dryness at the same time for three seconds to turn the control lock on or off. When the control lock function is turned on, the only button that works is the  Power button.
7	Dryness	Press the button to select the dryness level (More Dry, Normal Dry, Less Dry, or Damp Dry). A different dryness level will result in different drying times. For clothes to be ironed manually, a lower dryness level should be selected.
8	Damp Dry Signal	Press and hold Time Dry and Wrinkle Care to turn the Damp Dry Signal on or off. When turned on, the dryer beeps six times when the moisture in the clothes is good for ironing. Remove the items you want to iron, then press  Start/Pause to continue drying the rest of the load. The dryer will not stop operating if you don't take the garments out.
9	Wrinkle Care	Press to add or remove the Wrinkle Care step to the operating program. The "Wrinkle Care" indicator lights up when turned on. Wrinkle Care provides approximately 90 minutes of intermittent tumbling in unheated air at the end of the cycle to reduce wrinkling. The load is already dry and can be removed at any time during the Wrinkle Care cycle.
10	Time Adjust + / Time Adjust -	Press repeatedly to select the drying time. This button only works for the Quick Dry, Time Dry, and Air Fluff cycles.
11	Start/Pause	Press to start or pause the program. You can't change any settings. Pause the program to add a garment.

PREPARING FOR INSTALLATION

To prepare the dryer for installation:

1. Make sure that your installation location meets the requirements for a safe installation. See "[Checking installation requirements](#)" on page [Z](#).
2. If needed, adjust the dryer to vent from the side or the bottom. By default, the dryer is set up to vent from the rear. See "[Changing the vent location](#)" on page [14](#).
3. If needed, reverse the dryer door to open on the opposite side for easier access. See "[Reversing the door](#)" on page [15](#).

CHECKING INSTALLATION REQUIREMENTS

Follow these guidelines to correctly position the dryer based on its space, duct, exhausting, gas, electric, and grounding requirements.

SPACE REQUIREMENTS

- **The dryer must be exhausted outside to reduce the risk of fire.** This dryer is factory-ready for the rear exhaust option. If you want to change the vent location, see "[Changing the vent location](#)" on page [14](#).
- **Do not install any other fuel-burning appliance in the same closet as the dryer.**

- The room's ambient temperature should not be lower than 33°F (0.6°C).
- For gas dryers, there must be enough clearance to have adequate air for combustion, as noted on the rating label.
- The dryer must not be installed or stored in an area where it will be exposed to water and/or weather.
- The dryer area must be kept clear of combustible materials, gasoline, and other flammable vapors and liquids. A dryer produces combustible lint. The area around the dryer should be kept lint-free.
- Place the dryer in a location that lets the door open fully, allows for air circulation, and leaves space for the exhaust system.

- The washer is 41.7 in. (105.9 cm) high and 27 in. (68.6 cm) wide.

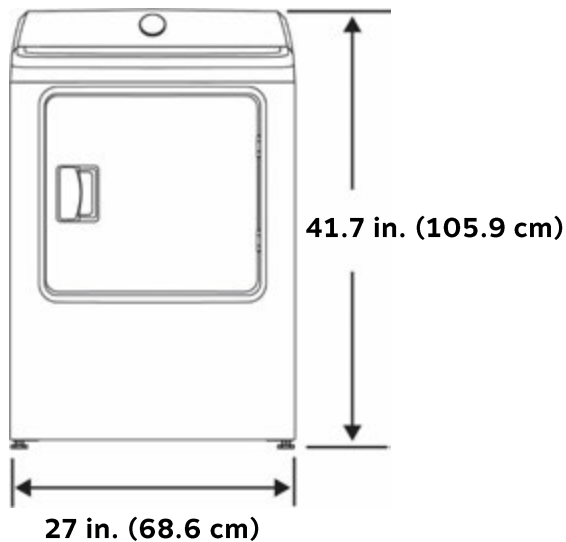

- The washer is 30 in. (76.3 cm) deep with the door closed and 49.2 in. (125.0 cm) with the door open.

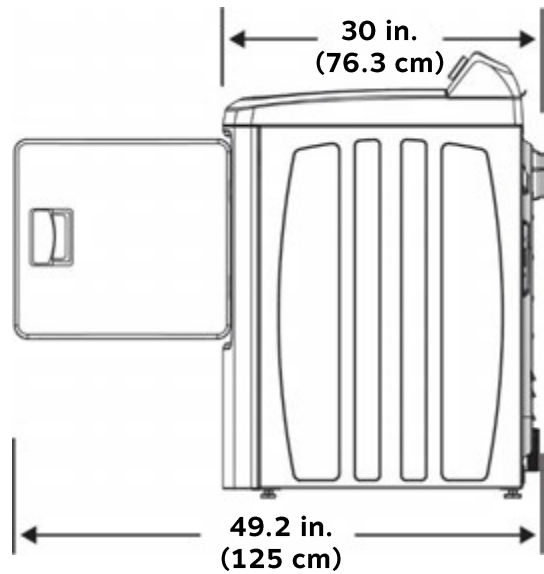

- You must have at least 1 in. (2.5 cm) of space to the sides of the dryer.

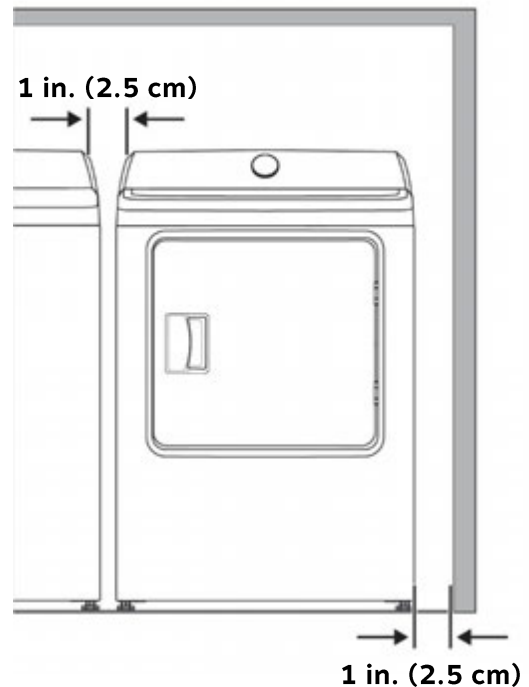

- You must have at least 24 in. (61.0 cm) of space above, 5 in. (12.7 cm) behind, and 2 in. (5.1 cm) in front of the dryer.

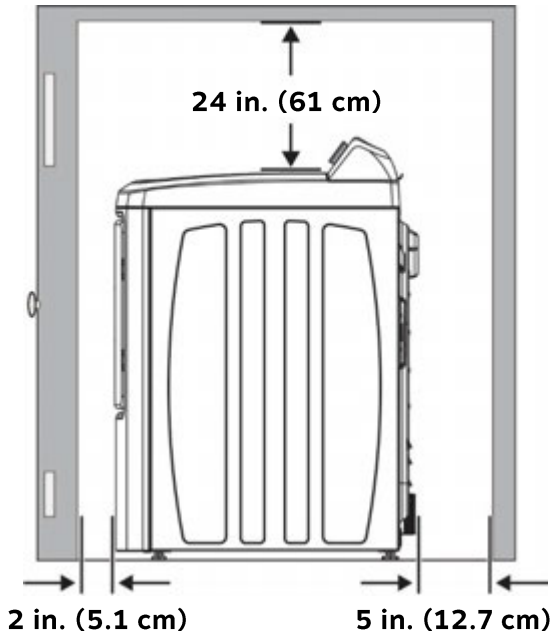

- If the dryer is installed in a closet, the door must have two unobstructed air openings with a combined total area of at least 72 in.² (465 cm²) and at least 3 in. (7.6 cm) of clearance at the top and bottom. A slatted door that meets these requirements is acceptable.

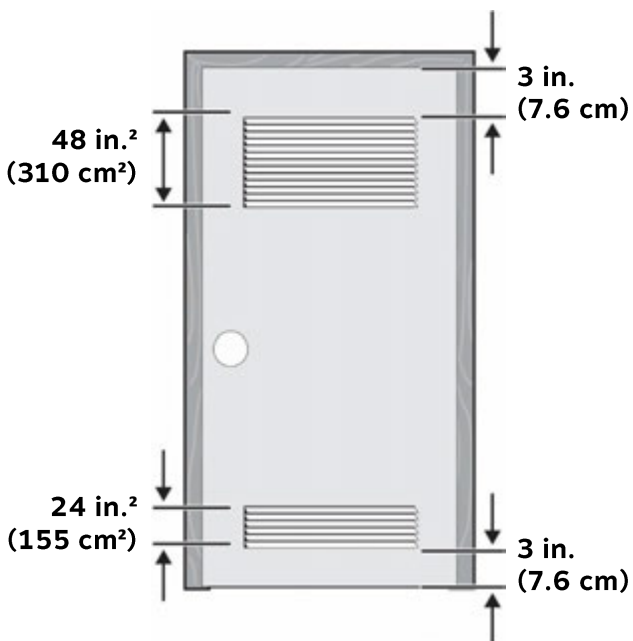

DUCT REQUIREMENTS

The maximum length your ducts can run depends on your weather hood type and the number of 90-degree turns your duct makes:

- If your weather hood has a 4 in. (10.2 cm) opening or uses a slatted cover, see [“Recommended duct installation”](#) on page 9.
- If your weather hood has a smaller, 2.5 in. (6.4 cm) opening, see [“Short-run duct installation”](#) on page 9.

See [“Additional duct requirements”](#) on page 10 to review other requirements and make sure that your ducts are safe to use.

Recommended duct installation

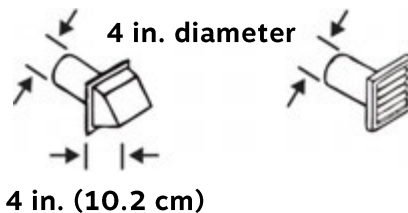

# OF 90° ELBOWS	MAXIMUM DUCT LENGTH
0	90 ft. (27.4 m)
1	60 ft. (18.3 m)
2	45 ft. (13.7 m)
3	35 ft. (10.7 m)

Short-run duct installation

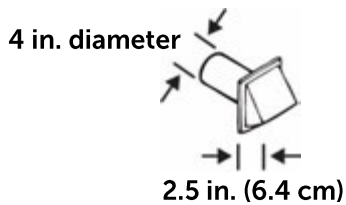

WARNING

# OF 90° ELBOWS	MAXIMUM DUCT LENGTH
0	60 ft. (18.3 m)
1	45 ft. (13.7 m)
2	35 ft. (10.7 m)
3	25 ft. (7.6 m)

Additional duct requirements

If this new dryer is installed into an existing exhaust system:

- Make sure that the exhaust system meets all local, state, and national codes.
- Make sure that the exhaust system is not using flexible plastic duct.
- Inspect and clean all lint buildup from inside the existing duct.
- Make sure that the duct is not dented or crushed.
- Make sure that the exhaust hood damper opens and closes freely.
- For best results, the static pressure in any exhaust system should be between 0.3 to 0.8 in. (0.8 to 2.0 cm) of water column, and it cannot be less than 0 under any circumstances with a 4 in. (10.2 cm) diameter duct.

i Manometer measurement must be done with the empty dryer working with a manometer at the point where the exhaust duct connects to the dryer. A no-heat setting should be used, and the lint filter must be clean.

- Use a 4-inch (10.2 cm) diameter rigid aluminum or rigid galvanized steel duct.
- Do not use ducts with smaller diameter than recommended.
- Ducts larger than 4 inches (10.2 cm) in diameter can result in increased accumulation of lint and changes in performance.
- Lint should be removed regularly from the internal filter every cycle and from ducts every year.
- If a flexible metal duct must be used, use the type with a stiff sheet metal wall. Do not use a flexible duct with a thin foil wall. A serious blockage can result if the flexible metal duct is bent too sharply.
- Never install any type of flexible duct in walls, ceilings, or other concealed spaces.
- Keep the exhaust duct as straight and short as possible and with a minimum number of elbows.
- Secure joints with aluminum tape. Do not use screws.
- Plastic flexible ducts can kink, sag, be punctured, reduce airflow, extend drying times, and affect the dryer operation.
- Exhaust systems longer than the recommended 90 ft. (27.4 m) can extend drying times, affect machine operations, and collect lint.
- The exhaust duct should end with an exhaust hood with a swing-out damper to prevent back drafts and entry of wildlife. Never use an exhaust hood with a magnetic damper.
- The hood should have at least 12 inches (30.5 cm) of clearance between the bottom of the hood and the ground or other obstruction. The hood opening should point down.
- Never install a screen over the exhaust outlet.

- To avoid lint buildup, do not exhaust the dryer directly into a window well. Do not exhaust under a house or porch.
- If the exhaust duct must run through an unheated area, the duct should be insulated and slope slightly down towards the exhaust hood to reduce condensation and lint buildup.
- Inspect and clean the interior of the exhaust system at least once a year. Unplug the power cord before cleaning.
- Check frequently to make sure the exhaust hood damper opens and closes freely.
- Check the vent duct once per month, and clean at least once per year.

**WARNING**

- NEVER USE A PLASTIC OR NON-METAL FLEXIBLE DUCT.
- If your existing ductwork is plastic, non-metal, or combustible, replace it with metal before installing this appliance.
- Use only a metal exhaust duct that is non-flammable to ensure containment of the exhaust air heat and lint.
- See “[Duct requirements](#)” on page 9 for the maximum duct length and number of bends.
 - All dryers must be exhausted to the outside.
 - Do not assemble the duct with screws or other fastening means that extend into the duct and catch lint.
 - The exhaust duct should be 4 inches (10.2 cm) in diameter.
 - The total length of flexible metal duct shall not exceed 7.8 ft. (2.4 m).

i If your clothes are not getting dry, check the ducting for obstructions.

- Do not exhaust the dryer into a wall, ceiling, crawl space, or concealed space of a building, gas vent, or any other common duct or chimney. This could create a fire hazard from the lint expelled by the dryer.
- Do not use a non-metallic flexible duct.
- To reduce the risk of fire, this dryer **MUST BE EXHAUSTED OUTDOORS**.

EXHAUSTING REQUIREMENTS**WARNING**

- The dryer shall not be exhausted into a chimney, a wall, a ceiling, an attic, a crawl space, or a concealed space of a building.
- The dryer must be exhausted to the outside to reduce the risk of fire when installed in an alcove or closet.

i Exhausting the dryer to the outside will prevent large amounts of lint and moisture from being blown into the room.

GAS REQUIREMENTS

i These gas requirements apply only to gas dryer installations (ENTD1064GXBW), not electric dryers (ENTD1064EXBW).

- Use only natural or LP (liquid propane) gases.
- **THE INSTALLATION MUST CONFORM WITH LOCAL CODES, OR IN THE ABSENCE OF LOCAL CODES, WITH THE NATIONAL FUEL GAS CODE, ANSI Z223.1/NFPA 54, LATEST REVISION (FOR THE UNITED STATES), OR THE NATURAL GAS AND PROPANE INSTALLATION CODE, CSA B149.1, LATEST REVISION (FOR CANADA).**
- Gas dryers are equipped with a burner vent for use with natural gas. If you plan to use your dryer with LP (liquid propane) gas, it must be converted for safe and proper performance by a qualified service technician.

- A 1/2-inch (1.27 cm) gas supply line is recommended and must be reduced to connect to the 3/8-inch (1 cm) gas line on your dryer. The National Fuel Gas Code requires that an accessible, approved manual gas shut-off valve be installed within 6 in. (15.24 cm) of your dryer.
- **Gas dryers installed in residential garages must be raised 18 in. (46 cm) above the floor.**
- Additionally, a 1/8 in. (0.3 cm) N.P.T. (National Pipe Thread) plugged tapping, accessible for test gauge connection, must be installed immediately upstream of your dryer's gas supply connection.
- Your dryer must be disconnected from the gas supply pipe system during any pressure testing of the system.
- This dryer must be connected to the gas supply piping with a listed flexible gas connector that complies with the standard for connectors for gas appliances, ANSI Z21.24 or CSA 6.10.
- **DO NOT** reuse old flexible metal gas lines. Flexible gas lines must be design certified by the American Gas Association (CGA in Canada).
 - Any pipe joint compound used must be resistant to the action of any liquefied petroleum gas.
 - As a courtesy, most local gas utilities will inspect a gas appliance installation.
- **GAS IGNITION:** Your dryer uses an automatic ignition system to ignite the burner. There is no constant burning pilot.
- **COMMONWEALTH OF MASSACHUSETTS INSTALLATION INSTRUCTIONS**

Your dryer must be installed by a licensed plumber or gas fitter. A "T" handle manual gas valve must be installed in the gas supply line to the installed dryer at the location of operation. If a flexible gas connector is used to connect the dryer, the connector may not be longer than 36 in. (91.5 cm).

**WARNING:**

- Gas leaks may occur in your system, creating a dangerous situation.
- Gas leaks may not be detected by smell alone.
- Gas suppliers recommend that you purchase and install a UL approved gas detector.
- Install and use it in accordance with the manufacturer's instructions.

ELECTRIC REQUIREMENTS

The wiring diagram is located on the back board of the unit.

**WARNING**

- The improper connection of the equipment grounding conductor can result in the risk of electric shock. Check with a qualified electrician or serviceman if you are in doubt as to whether your dryer is properly grounded. Do not modify the plug provided with your dryer - if it doesn't fit the outlet, have a proper outlet installed by a qualified electrician.
- To prevent unnecessary risk of fire, electrical shock, or personal injury, all wiring and grounding must be done in accordance with local codes, or in the absence of local codes, with the National Electrical Code, ANSI/NFPA No. 70 - Latest Revision (for the U.S.) or the Canadian Electrical Code CSA C22.1 - Latest Revisions and local codes and ordinances. It is your responsibility to provide adequate electrical services for your dryer.
- All gas installations must be done in accordance with the National Fuel Code ANSI/Z2231 - Latest Revision (for the U.S.) or CAN/CGA - B149 Installation Codes - Latest Revision (for Canada) and local codes and ordinances.

Electrical Connections

An individual branch (or separate) circuit serving only your dryer is recommended. **DO NOT USE AN EXTENSION CORD.**

Gas Models - U.S. and Canada

A 120-volt, 60 Hz AC approved electrical service, with a 15-ampere fuse or circuit breaker is required.

Electric Models - U.S. Only

The dryers require a 120/240 volt, 60Hz AC approved electrical service. The electric service requirements can be found on the data label located behind the door. A 30-ampere fuse or circuit breaker on both sides of the line is required.

- If a power cord is used, the cord should be plugged into a 30-ampere receptacle.
- The power cord is NOT provided with U.S. electric model dryers.

**WARNING****Electrical Shock Hazard**

When local codes allow, the electrical supply of the dryer may be connected by means of a new power supply cord kit, marked for use with a dryer, that is UL listed and rated at a minimum of 120/240 volts, 30-ampere with three No. 10 copper wire conductors terminated with closed loop terminals, open-end spade lugs with turned up ends, or with tinned leads.

- Do not reuse a power supply cord from an old dryer.
- The power cord electric supply wiring must be retained at the dryer cabinet with a suitable UL-listed strain relief.

Grounding through the neutral conductor is prohibited for (1) new branch-circuit installations, (2) mobile homes, (3) recreational vehicles, and (4) areas where local codes prohibit grounding through the neutral conductor. (Use a 4-prong plug for 4 wire receptacles, NEMA type 14-30R.)

Electric Models - Canada Only

- A 120/240-volt, 60 Hz AC approved electrical service fused through a 30-ampere fuse or circuit breaker on both sides of the line is required.

- All Canadian models are shipped with the power cord attached. The power cord should be plugged into a 30-ampere receptacle.

GROUNDING REQUIREMENTS

This dryer must be grounded. In the event of a malfunction or breakdown, the grounding the product will reduce the risk of electrical shock by providing a path of least resistance for the electrical current.

Gas and Electric Models**WARNING**

Certain internal parts are intentionally not grounded and may present a risk of electric shock only during servicing. Service Personnel – Do not contact the following parts while the appliance is energized: inlet valve, control board, and temperature-regulating thermistor (located on blower housing).

Gas Models**WARNING**

- Your dryer has a three-prong power cord with grounding conductor (120 V/60 Hz).
- The plug must be plugged into an appropriate individual outlet that is properly installed and grounded in accordance with all local codes and ordinances.

Electric Models**WARNING**

- Dryer must be grounded with 3 or 4 wire cord power cord with a ground grounding conductor and a grounding plug, which is sold separately.
- The plug must be plugged into an appropriate outlet that is properly installed and grounded in accordance with all local codes and ordinances.
- Do not modify the plug provided with your dryer - if it doesn't fit the outlet, have a proper outlet installed by a qualified electrician.

- If a power cord is not used and the electric dryer is to be permanently wired, the dryer must be connected to a permanently grounded metal wiring system, or an equipment grounding conductor must be run with the circuit conductors and connected to the equipment grounding terminal or lead on the dryer.

CHANGING THE VENT LOCATION

This dryer is shipped to vent to the rear. It can also be configured to vent to the bottom or left side (as seen from the front).

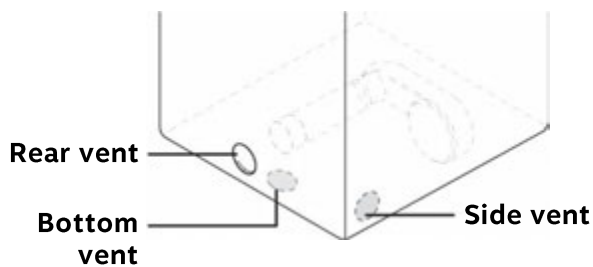

Adapter kits, which are standard components, can be purchased from any retailer. These kits contain the necessary duct components to change the dryer vent location.

You will need a Phillips screwdriver, aluminum tape, 4-inch (10.2 cm) diameter duct (rigid or UL-listed flexible metal), 4-inch (10.2 cm) elbow, and protective gloves.

Decide how you want the dryer to vent:

- If you want the dryer to vent from the side, see [“Venting from the side”](#) on page 14.
- If you want the dryer to vent from the bottom, see [“Venting from the bottom”](#) on page 15.

VENTING FROM THE SIDE

1. Remove the two rear exhaust retaining screws, then pull out the exhaust duct.

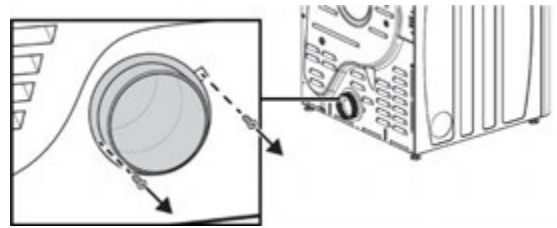

2. Press the tabs on the knockout and carefully remove the knockout for the desired vent opening.

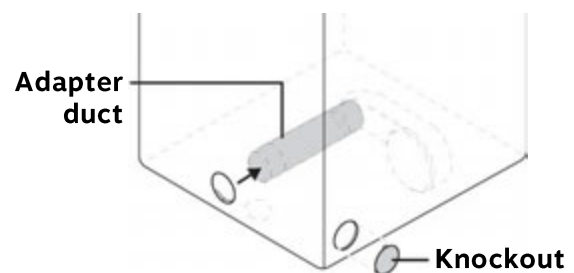

3. Attach the adapter duct onto the blower housing of the dryer.
4. Attach the 4-inch (10.2 cm) elbow to the 4-inch (10.2 cm) duct, then secure all joints with aluminum tape. Make sure that the male end of the elbow faces AWAY from the dryer.
5. Insert the elbow/duct assembly through the side opening and attach it to the adapter duct, securing in place with aluminum tape. Make sure that the male end of the duct protrudes 1.5 in. (3.8 cm) from the dryer to connect the remaining ductwork.

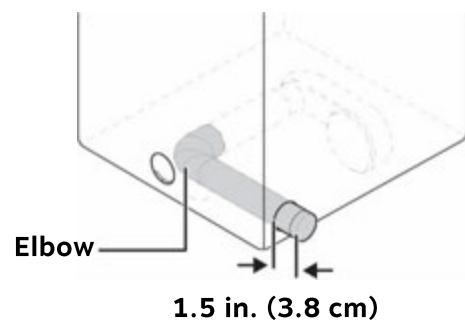

- Cover the original dryer vent hole (on the back of the dryer) with aluminum tape.

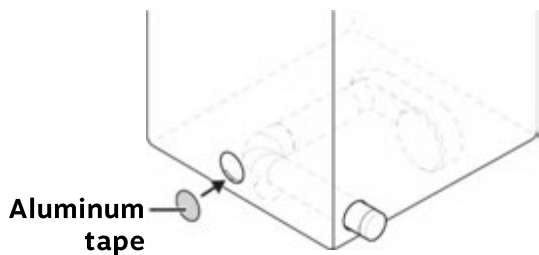

- (3.8 cm) from the dryer to connect the remaining ductwork.

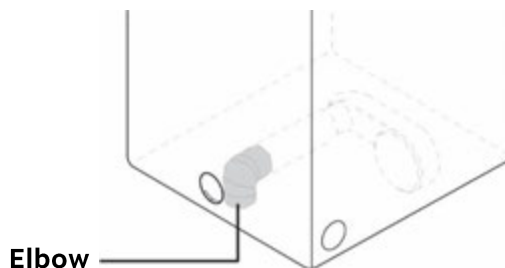

VENTING FROM THE BOTTOM

- Remove the two rear exhaust retaining screws, then pull out the exhaust duct.

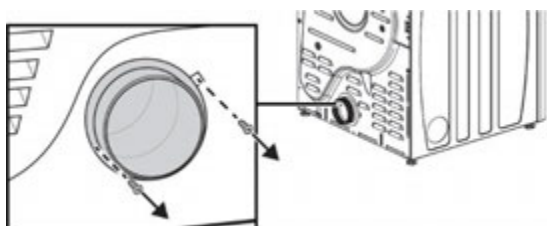

- Carefully lay the dryer down on its side to access the bottom. Have someone help you.
- Press the tabs on the knockout and carefully remove the knockout for the desired vent opening.

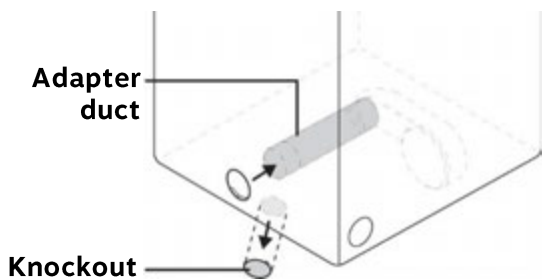

- Attach the adapter duct onto the blower housing of the dryer.
- Attach the 4-inch (10.2 cm) elbow to the 4-inch (10.2 cm) duct, then secure all joints with aluminum tape. Make sure that the male end of the elbow faces DOWN through hole in the bottom of the dryer.
- Insert the elbow/duct assembly through the rear opening and attach it onto the adapter duct, securing in place with aluminum tape. Make sure that the male end of the duct protrudes 1.5 in.

- Cover the original dryer vent hole (on the back of the dryer) with aluminum tape.

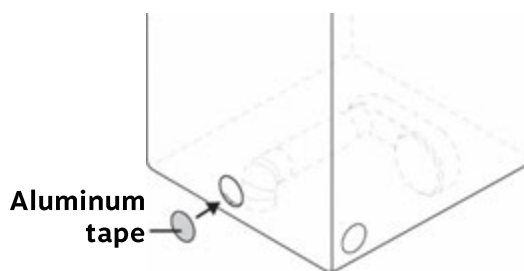

REVERSING THE DOOR

You will need a Phillips screwdriver.

- Make sure that the power cord is unplugged.
- While supporting the door, remove the four hinge screws from the door, then lift the door to remove it and set it aside.

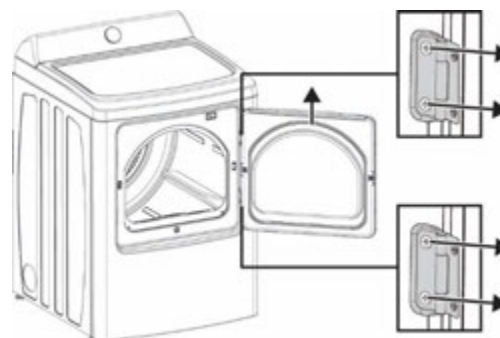

- Remove the screws for the locker cover on the right side of the dryer and the screws for the locker on the left side of the dryer.

4. Install the locker onto the right side of the dryer with the screws you just removed, then install the locker cover on the left side of the dryer.

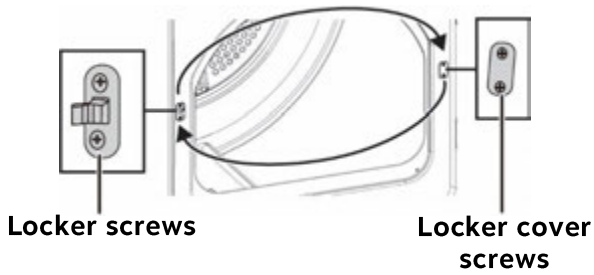

5. Remove the 12 screws around the door.

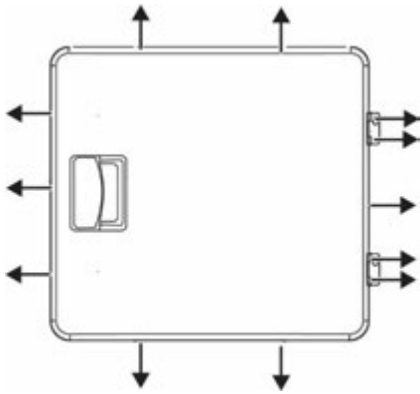

6. Pull the inside door board from the outside door board.

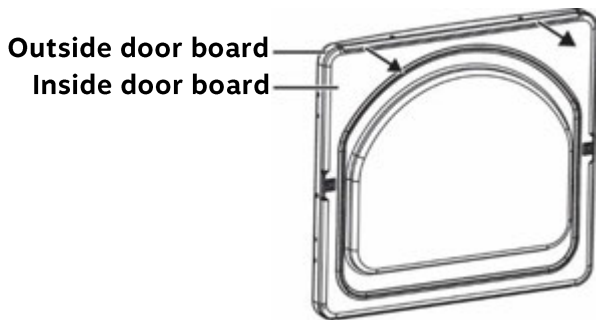

7. Rotate the outside door board 180°.

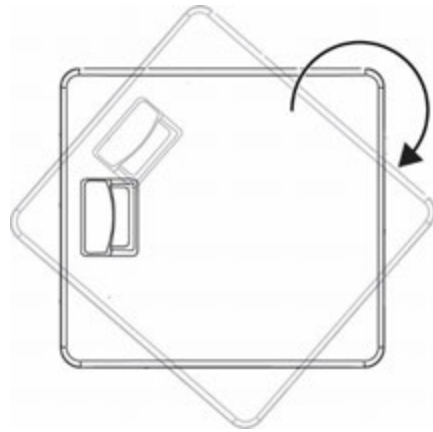

8. Reassemble the outside and inside door boards with the screws you removed previously.

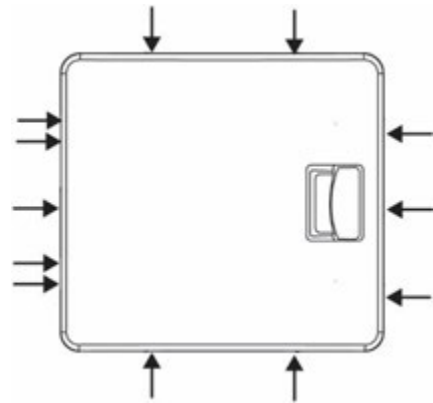

9. Install the hinges onto the left side of the dryer.

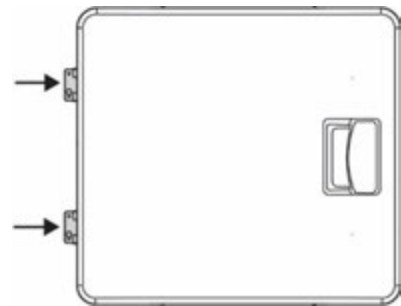

10. Align the hinges on the door with the hinge screw holes on the front of your dryer, then secure the door with the four screws you previously removed.

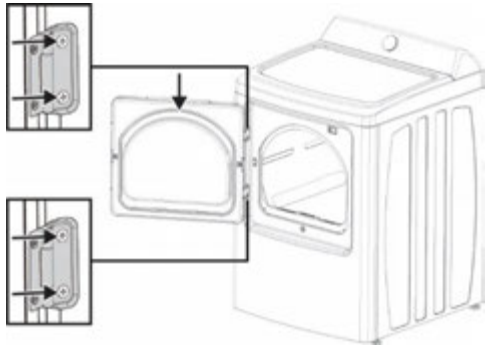

SETTING UP YOUR DRYER

WARNING: To prevent personal injury or strain, wear protective gloves whenever lifting or carrying the unit.

For the proper installation, we recommend that you hire a qualified installer. Before using your dryer for the first time:

1. Unpack the dryer. See “[Unpacking the dryer](#)” on page [17](#).
2. Position the dryer. See “[Positioning the dryer](#)” on page [17](#).
3. Connect the exhaust system. See “[Connecting the exhaust system](#)” on page [17](#).
4. If installing a gas dryer, connect the gas line. See “[Connecting the gas line \(gas models only\)](#)” on page [18](#).
5. Connect the electrical wiring. See “[Connecting the electrical wiring](#)” on page [19](#).
6. Level the dryer. See “[Leveling the dryer](#)” on page [21](#).
7. Plugging in the dryer. See “[Powering the dryer](#)” on page [21](#).

UNPACKING THE DRYER

1. Unpack the dryer and check it for shipping damage.

WARNING: Packaging materials can be dangerous to children. Keep all packaging material (plastic bags, polystyrene, etc.) well out of children’s reach.

2. Make sure that you received all the items in the package contents list.

POSITIONING THE DRYER

Move the dryer to a location that meets the installation requirements. See “[Space requirements](#)” on page [7](#).

CONNECTING THE EXHAUST SYSTEM

You will need 4 in. (10.2 cm) diameter rigid metal duct and aluminum tape.

1. Review the “[Duct requirements](#)” on page [9](#) before installing the exhaust system.

2. Connect the duct to the exhaust hood and secure with aluminum tape. The crimped end of the duct sections must point away from the dryer.

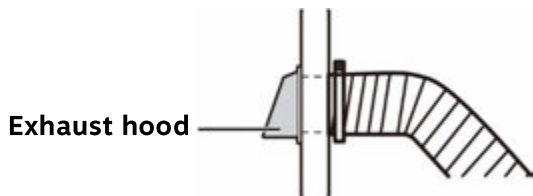

3. Connect the duct to the venting hole on the back, side, or bottom of the dryer and secure with aluminum tape. Do not cover the ventilation holes on the back of the dryer cabinet.

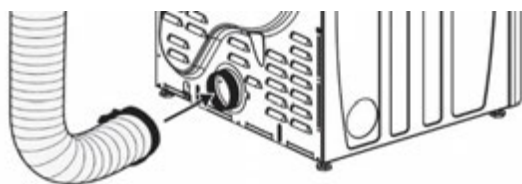

i For a tight installation, attach a section of the exhaust system onto your dryer before putting it in place.

⚠ WARNING:

- Make sure your dryer is installed properly so it exhausts air easily.
- Keep ducts as straight as possible.
- DO NOT restrict your dryer with a poor exhaust system.
- DO NOT use unnecessarily long ducts that have many elbows.
- Use a 4 in. (10.2 cm) diameter rigid metal duct. Tape all joints, including at the dryer. Never use lint-trapping screws.
- Clean all old ducts before installing your new dryer. Be sure the vent flap opens and closes freely. Inspect and clean the exhaust system annually.
- DO NOT use a plastic, thin foil, or non-metal flexible duct.
- DO NOT use dented or clogged ducts and vent.

CONNECTING THE GAS LINE (GAS MODELS ONLY)

You will need gas piping, pipe joint compound or thread seal tape, a wrench, and a soap solution (to check for leaks).



WARNING:

- All gas installations of the dryer must be equipped with Manual Shut-Off valve.
- Uncoated copper tubing will corrode when subjected to natural gas, causing gas leaks. Use ONLY black iron, stainless steel, or plastic-coated brass piping for the gas supply.

1. Review the “Gas requirements” on page 11 before connecting the gas line.
2. Remove the protective pipe thread cap from the gas inlet on the back of the dryer.

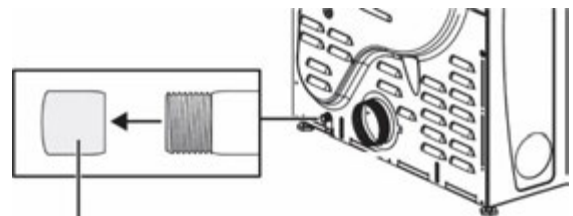

Thread cap

3. Apply a pipe joint compound or 1.5 in. (3.8 cm) wraps of thread seal tape over all threaded connections.

Manual

shutoff valve Flare union

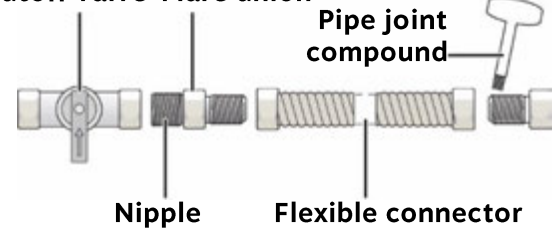

i The pipe joint compound must be resistant to the actions of any liquefied petroleum gas.

4. Connect the pipe joints and tighten with a wrench.

5. Connect the gas supply to the gas inlet on the back of the dryer.

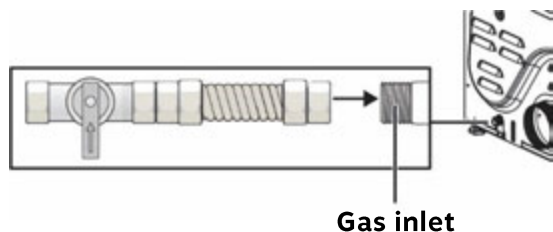

- ① An additional fitting is required to connect the $\frac{3}{4}$ in. (1.9 cm) female thread end of a flexible connector to the $\frac{3}{8}$ in. (1 cm) male threaded end on the dryer. Use only new AGA or CSA certified gas supply line with SS flexible connectors within 6 ft. (1.8 m) of the dryer.

6. Securely tighten the gas line fitting over the threads with a wrench.
7. Turn on the gas supply.

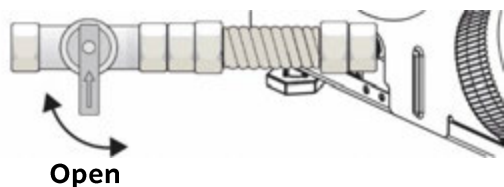

8. Check all gas connections for leaks using a soap solution. If bubbles appear, tighten the connections, and then recheck it.

- ⚠ **WARNING:** DO NOT use an open flame to check for gas leaks.

CONNECTING THE ELECTRICAL WIRING

You will need a Phillips screwdriver.

Review the “[Electric requirements](#)” on page [12](#) before connecting electrical wiring.

Before operating or testing, follow the instructions in “[Grounding requirements](#)” on page [13](#).



WARNING:

Electrical Shock Hazard

All U.S. models are produced for a 3-WIRE SYSTEM CONNECTION.

The dryer frame is grounded to the neutral conductor at the terminal block. A 4-WIRE SYSTEM CONNECTION is required for new or remodeled construction, mobile homes, or if local codes do not permit grounding through neutral conductor. If the 4-wire system is used, the dryer frame cannot be grounded to the neutral conductor at the terminal block. See “[Electric requirements](#)” on page [12](#) for 3-wire or 4-wire connections.

1. Remove the terminal block cover plate.
2. Insert the power cord with a UL-listed strain relief through the hose provided in the cabinet near the terminal block. A strain relief must be used.
3. Do not loosen the nuts already installed on the terminal block. Be sure they are tight. Use a $\frac{3}{8}$ in. (1 cm) deep-well socket.

Three-wire outlet connections



3-Wire Receptacle (10-30R)

Choose a 3-wire power supply cord with ring or spade terminals and UL listed strain relief. The 3-wire power supply cord, at least 4 ft. (1.22 m) long, must have three 10-gauge solid copper wires and match a 3-wire receptacle of NEMA Type 10-30R.

1. Remove the center terminal block screw.
2. Connect the neutral wire (white or center wire) of the power cord to the center terminal screw of the terminal block. Be sure to cross the screw through the ring of the power cord terminal and tighten the screw.
3. Connect the other wires to the outer terminal block screws. Be sure to cross the screw through the terminal ring and tighten the screw.
4. Tighten the strain relief screws.

5. Insert the tab of the terminal block cover into your dryer's rear panel slot. Secure the cover with a screw.

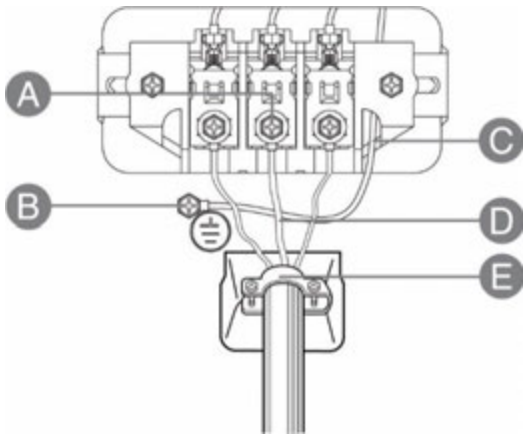

LETTER	DESCRIPTION
A	Center terminal block screw
B	External ground connector
C	Neutral grounding wire (White)
D	Neutral wire (white or center wire)
E	$\frac{3}{4}$ in. (1.9 cm) UL-listed strain relief



WARNING: If converting from a 4-wire electrical system to a 3-wire, the ground strap must be reconnected to the terminal block support to ground the dryer frame to the neutral conductor. Ring-type terminals are recommended. If using strap terminals, make sure they are tightened.

Four-wire outlet connections

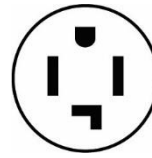

4-Wire Receptacle (14-30R)

Choose a 4-wire power supply cord with ring or spade terminals and UL listed strain relief. The 4-wire power supply cord, at least 4 ft. (1.22 m) long, must have 4 10-gauge solid copper wires and match a 4-wire receptacle of NEMA Type 14-30 R. The ground wire (ground conductor) may be either green or bare. The neutral conductor must be identified by a white color.

1. Remove the center terminal block screw.
2. Connect the ground wire (green or unwrapped) of the power cord to the external ground conductor screw.
3. Connect the neutral wire (white or center wire) of the power cord and the appliance ground wire (white) under the center screw of the terminal block. Be sure to cross the screw through the ring of the power cord terminal and tighten the screw.
4. Connect the other wires to the outer terminal block screws. Be sure to cross the screw through the terminal ring and tighten the screw.
5. Tighten the strain relief screws.

6. Insert the tab of the terminal block cover into your dryer's rear panel slot. Secure the cover with a screw.

ⓘ Ring-type terminals are recommended. If using strap terminals, make sure that they are tightened.

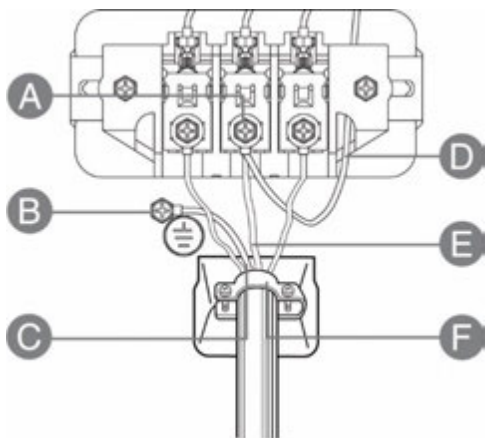

LETTER	DESCRIPTION
A	Center terminal block screw
B	External ground connector
C	Green or bare copper wire of the power cord
D	Neutral grounding wire (white)
E	Neutral wire (white or center wire)
F	3/4-inch (1.9 cm) UL-listed strain relief

LEVELING THE DRYER

The dryer must be level for optimal drying performance. To minimize vibration, noise, and unwanted movement, the floor must be a perfectly level, solid surface.

1. Place a level on top of the washer.
 - If the level's bubble is between the lines, the washer is level.

- If the level's bubble is not between the lines, the washer is not level.
2. Adjust your washer by turning the front leveling feet clockwise (to lower) or counterclockwise (to raise).

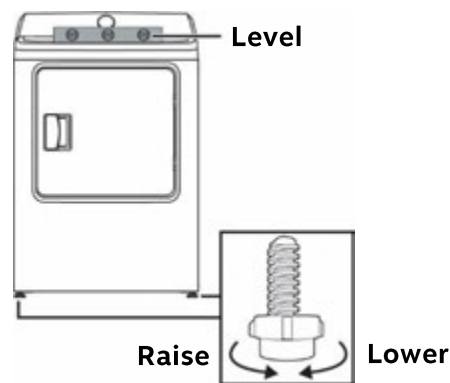

POWERING THE DRYER

1. Make sure that all gas connections (gas model only), exhaust, and electrical connections are complete.
2. Plug in the dryer.

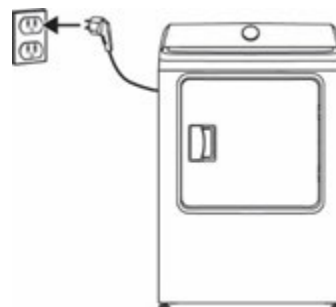

3. Start your dryer to confirm that it runs, heats, and shuts off.

CAUTION: The burner may not ignite initially due to air in the gas line. Allowing your dryer to operate on a heat setting will purge the line. If the gas does not ignite within five minutes, turn your dryer off and wait five minutes. Be sure the gas supply to your dryer has been turned on. In order to confirm the gas ignition, check the exhaust for heat.

USING YOUR DRYER

DRYING A LOAD OF LAUNDRY

Complete these steps to dry a load of laundry:

1. Clean the filter. See “[Clean the filter](#)” on page 22 for more information.
2. Load your laundry into the dryer. See “[Load the laundry](#)” on page 22 for more information.
3. Select a cycle and options. See “[Select a cycle](#)” on page 22 for more information.

CLEAN THE FILTER

To prevent a risk of fire, make sure to clean the lint filter before or after every load. This shortens your drying time and helps the dryer be more energy efficient.

1. Remove the lint filter from inside the dryer.

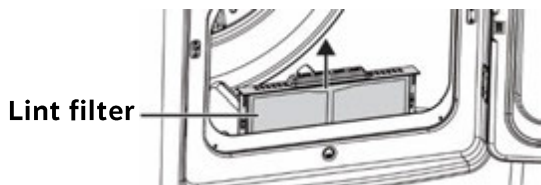

2. Clean off the lint and throw it away.
3. Replace the lint filter in the dryer.

⚠ CAUTION:

- Do not operate your dryer without the lint filter in place.
- Do not use a damaged or broken lint filter. This may reduce performance and/or cause fire.

LOAD THE LAUNDRY

- Place only one wash load in your dryer at a time. Overloading restricts tumbling action, resulting in uneven drying as well as excessive wrinkling of some fabrics.
- Mixed loads of heavy and lightweight fabrics will dry differently. This may result in lightweight fabrics being dry while heavy

fabrics remain damp at the end of a drying cycle.

- Add one or more similar items to your dryer when only one or two articles of clothing need drying. This improves the tumbling action and drying efficiency.

SELECT A CYCLE

1. Press **Power** to turn on the dryer. The “Clean Filter” light in the process bar flashes 10 times when the dryer is turned on. Make sure that the filter is clean.
2. Turn the cycle selector to the appropriate cycle for your load. See “[Understanding cycles and options](#)” on page 24 for detailed information about each of the cycles.



3. Adjust the optional settings you want to use during the cycle. See “[Understanding cycles and options](#)” on page 24 for detailed information about each of the available options.
4. Press **Start/Pause** to begin the cycle.

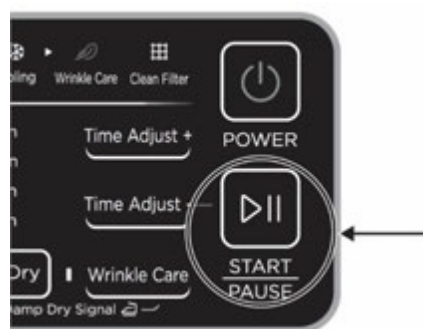

SETTING THE CONTROL LOCK

The control lock prevents children from playing with the dryer. When the control lock is turned on, the only functions that work are the  Power button and deactivating the lock.

Press and hold **Temp.** and **Dryness** for three seconds to turn the control lock on or off. The control lock light turns on or off.

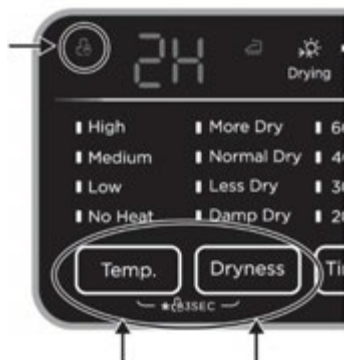

 The control lock is automatically cancelled if the dryer loses power or is unplugged.

UNDERSTANDING CYCLES AND OPTIONS

Settings highlighted in gray indicate default settings after selecting a cycle. Options with “Yes” can be selected with the indicated cycle. For better drying results, select a higher dryness level. Follow your garment’s label requirements.

CYCLE	FABRIC TYPE	TEMP.	DRY LEVEL	WRINKLE CARE	DAMP DRY SIGNAL	TIME ADJUST	DEFAULT TIME	WET LOAD (MAX AMT.)
Normal	<ul style="list-style-type: none"> • Cotton • Underwear • Linen 	Medium	More Dry	Yes	Yes	No	50 min.	
			Normal Dry					
			Less Dry					
			Damp Dry					
Heavy Duty	<ul style="list-style-type: none"> • Jeans • Corduroys • Work clothes 	High	More Dry	Yes	Yes	No	67 min.	
			Normal Dry					
			Less Dry					
			Damp Dry					
Bulky	<ul style="list-style-type: none"> • Blankets • Sheets • Comforters 	Medium	More Dry	Yes	Yes	No	62 min.	
			Normal Dry					
			Less Dry					
			Damp Dry					
Towels	<ul style="list-style-type: none"> • Towels • Heavy cottons 	High	More Dry	Yes	Yes	No	58 min.	
			Normal Dry					
			Less Dry					
			Damp Dry					
Casual	<ul style="list-style-type: none"> • Wrinkle-free cottons • Synthetic fabrics • Knits 	Medium	More Dry	Yes	Yes	No	31 min.	
			Normal Dry					
			Less Dry					
			Damp Dry					
Delicates	Sensitive items	Low	More Dry	Yes	Yes	No	34 min.	
			Normal Dry					
			Less Dry					
			Damp Dry					
Sanitize	<ul style="list-style-type: none"> • Towels • Bedding • Children’s clothing 	High	More Dry	Yes	Yes	No	60 min.	
Quick Dry	n/a	High	n/a	Yes	No	Yes	30 min.	
		Medium						
		Low						
		No Heat						
Time Dry	n/a	High	n/a	Yes	No	Yes	40 min.	
		Medium						
		Low						
		No Heat						
Air Fluff	n/a	No Heat	n/a	Yes	No	Yes	20 min.	

DRYING TIPS

Follow the care label or manufacturer's instructions for drying special items. If care label instructions are not available, use the following information as a guide.





Do not dry fiberglass items (curtains, draperies, etc.), woolen items, unless recommended on the label, or items spotted or soaked with vegetable or cooking oils.

ITEMS	DRYING GUIDE
Bedspreads, comforters, and blankets	<ul style="list-style-type: none"> • Follow the care label instructions or use the Bulky cycle. Dry only one blanket at a time for best tumbling action. • Make sure the item is thoroughly dry before using or storing. • Reposition, if needed, to ensure even drying.
Curtains and draperies	<ul style="list-style-type: none"> • Use the Casual cycle, medium temperature, and less dry to help minimize wrinkling. • Dry in small loads and remove as soon as possible for best results.
Cloth diapers	<ul style="list-style-type: none"> • Use the Normal cycle on high temperature for soft, fluffy diapers.
Down-filled items (jackets, sleeping bags, comforters, etc.)	<ul style="list-style-type: none"> • Use the Normal cycle on high temperature. • Add a couple of dry towels to shorten drying time and absorb moisture.
Foam rubber (rug backs, stuffed toys, shoulder pads, etc.)	<ul style="list-style-type: none"> • DO NOT dry on a heat setting. Use the Air Fluff cycle (no heat). <p>WARNING: Drying a rubber item with heat may damage it or create a fire hazard.</p>
Pillows	<ul style="list-style-type: none"> • Use the Normal cycle. • Add a couple of dry towels and a pair of clean sneakers for best tumbling action and to fluff the item. • Dry kapok or foam pillows only with the Air Fluff cycle. Do not use any heated dry cycles.
Plastics (shower curtains, outdoor furniture covers, etc.)	<ul style="list-style-type: none"> • Use the Air Fluff or Time Dry cycles on low temperature, depending on the care label instructions.



CARING FOR FABRICS

The following symbols provide garment care instructions. Clothing care labels include symbols for washing, bleaching, drying, and ironing, or dry cleaning when necessary. The use of symbols ensures consistency among garment manufacturers of domestic and imported items. Follow care label directions to maximize garment life and reduce laundering problems.



WASH CYCLE

	Normal
	Permanent Press / Wrinkle Resistant / Wrinkle Control
	Gentle / Delicates
	Hand Wash



WATER TEMPERATURE

	Hot (105°–125°F / 41°–52°C)
	Warm (85°–105°F / 29°–41°C)
	Cold (60°–85°F / 16°–29°C)

BLEACH

	Any Bleach (when needed)
	Only Non-Chlorine (color-safe) Bleach (when needed)
	Tumble Dry Cycle

NORMAL

	Permanent Press / Wrinkle Resistant / Wrinkle Control
	Gentle / Delicates



SPECIAL INSTRUCTIONS

	Line Dry / Hang to Dry
	Drip Dry
	Dry Flat







HEAT SETTINGS

	High
	Medium
	Low
	Any Heat
	No Heat / Air







IRON-DRY OR STEAM TEMPERATURES

	High
	Medium
	Low

WARNING SYMBOLS

	Do Not Wash
	Do Not Wring
	Do Not Bleach
	Do Not Tumble Dry
	No Steam (added to iron)
	Do Not Iron

DRY CLEAN

	Dry Clean
	Do Not Dry Clean
	Line Dry / Hang to Dry
	Drip Dry
	Dry Flat
	Machine-washable wool. Loads should be under 8 lbs. (3.6 kg)

i The water temperature must be a minimum of 60°F (16°C) for detergent activation and effective cleaning. The washer cannot ensure these temperatures because the actual temperature of the water entering your washer depends on water heater settings and regional water supply temperatures. For example, cold water entering the home in the northern states during winter may be 40°F (4°C) which is too cold for effective cleaning. In this situation, you will need to adjust the water temperature by selecting a warm setting, adding some hot water to the MAX FILL line.

CLEANING THE DRYER



WARNING: Certain internal parts are intentionally not grounded and may present a risk of electric shock only during servicing. Service Personnel – Do not contact the following parts while the appliance is energized: inlet valve, control board, and temperature-regulating thermistor (located on blower housing).

CLEANING THE CONTROL PANEL

- Clean with a soft, damp cloth. Do not use abrasive substances.
- Do not spray cleaners directly on the panel.
- Some laundry pretreatment soil and stain remover products may damage the control panel finish. Apply such products away from your dryer and immediately wipe up any spills or overspray.

CLEANING THE INNER DRUM

- To clean the stainless steel or anodized drum, use a damp cloth with a mild, non-abrasive cleaner suitable for stainless steel and anodized surfaces.
- Remove cleaner residue and dry with a clean cloth.

CLEANING THE EXTERIOR

- Clean with a soft, damp cloth. Do not use abrasive substances.
- Protect the surface from sharp objects.
- Do not place heavy or sharp objects or a detergent box on the dryer as it may scratch or damage the top cover. Keep them on a pedestal (not included) or in a separate storage box.

- Since the entire dryer has a high-gloss finish, the surface can be scratched or damaged.
- Avoid scratching or damaging the surface when using the dryer.

CLEANING THE EXHAUST SYSTEM



- Inspect and clean yearly to maintain optimum performance.
- Disconnect the exhaust duct from the dryer and from the exhaust hood (at the exhaust outlet) outside of the building.
- Check the interior of the duct and remove any lint that has accumulated.
- Remove lint from the exhaust hood. Lint collected in the exhaust hood may prevent flappers or louvers from opening or closing completely.
- After cleaning the exhaust hood, check that the flapper or louvers move freely.
- Reassemble the exhaust duct and hood, checking that the joints are secure and sealed.
- Operate the dryer and verify that the exhaust air is not obstructed in the vent and that there are no leaks in the system.
- Clean the outside exhaust hood frequently to ensure proper operation.

SAFETY AND PRECAUTIONS

YOUR SAFETY AND THE SAFETY OF OTHERS ARE VERY IMPORTANT

To prevent injury to the user or other people and property damage, the instructions shown here must be followed. Incorrect operation due to ignoring of instructions may cause harm or damage, including death.

The level of risk is shown by the following indications:

 WARNING	This symbol indicates the possibility of death or serious injury.
 CAUTION	This symbol indicates the possibility of injury or damage to property.
 WARNING	This symbol indicates the possibility of dangerous voltage constituting a risk of electrical shock is present that could result in death or serious injury.

WARNING

For your safety, the information in this User Manual must be followed to minimize the risk of fire or explosion, or to prevent property damage, personal injury, or death.

- Do not store or use gasoline or other flammable vapors and liquids in the vicinity of this or any other appliance.
- Installation and service must be performed by a qualified installer, service agency, or the gas supplier.

FIRE HAZARD WARNING

- Failure to follow safety warnings exactly could result in serious injury, death, or property damage.
- Do not install a booster fan in the exhaust duct.

- Install all clothes dryers in accordance with the installation instructions of the manufacturer of the dryer.

WHAT TO DO IF YOU SMELL GAS

- Do not try to light any appliance.
- Do not touch any electrical switch; do not use any phone in your building.
- Clear the room, building, or area of all occupants.
- Immediately call your gas supplier from a neighbor's phone. Follow the gas supplier's instructions.
- If you cannot reach your gas supplier, call the fire department.

IMPORTANT SAFETY INSTRUCTIONS

To reduce the risk of fire, electric shock, or injury to persons when using your appliance, follow basic precautions, including the following:

1. Read all instructions before using the appliance.
2. Use this appliance only for its intended purpose as described in this User Manual.
3. Before use, the dryer must be properly installed as described in this manual.
4. ALWAYS follow the fabric care instructions supplied by the garment manufacturer.
5. Do not dry articles that have been previously cleaned in, washed in, soaked in, or spotted with gasoline, dry-cleaning solvents, or other flammable or explosive substances as they give off vapors that could ignite or explode.
6. Do not use the dryer to dry clothes which have traces of any flammable substance, such as vegetable oil, cooking oil, machine oil, flammable chemicals, thinner, or anything containing wax or chemicals, such as mops and cleaning cloths. Flammable substances may cause the fabric to catch fire by itself.

7. Do not store or use gasoline or other flammable vapors and liquids near this or any other appliance.
8. Do not allow children to play on or in the appliance. Close supervision of children is necessary when the appliance is used near children.
9. Before the appliance is removed from service or discarded, remove the door of the drying compartment.
10. Do not reach into the dryer if the drum is moving.
11. Do not install or store this dryer where it will be exposed to the weather or freezing temperatures below 33°F (0.6°C).
12. Do not tamper with the controls and latch.
13. Do not install a booster fan in the exhaust duct.
14. Do not repair or replace any part of the dryer or attempt any servicing unless it is specifically recommended in the user-maintenance instructions or in published user-repair instructions that you understand and have the skills to carry out.
15. Keep the area underneath and around your appliances free of combustible materials (lint, paper, rags, etc.), gasoline, chemicals, and other flammable vapors and liquids.
16. Do not place items exposed to cooking oils in your dryer. Items contaminated with cooking oils may contribute to a chemical reaction that could cause a load to catch fire. To reduce the risk of fire due to contaminated loads, the final part of a tumble dryer cycle occurs without heat (cool down period). Avoid stopping a tumble dryer before the end of the drying cycle unless all items are quickly removed and spread out so that the heat is dissipated.
17. Unplug the dryer if the machine is to be left for an extended period of time, such as during vacations.
18. Packaging material can be dangerous for children. There is a risk of suffocation! Keep all packaging from children.
19. Always check the inside of the dryer for foreign objects before loading laundry. Keep the door closed when not in use.
20. Do not use fabric softeners or products to eliminate static unless recommended by the manufacturer of the fabric softener or product manufacturer.
21. Clean the lint screen before or after each load.
22. Keep the area around the exhaust opening and surrounding areas free from lint, dust, and dirt.
23. The interior of the dryer and exhaust duct should be cleaned periodically by qualified service personnel.
24. This appliance must be grounded. See "[Electric requirements](#)" on page 12 and "[Grounding requirements](#)" on page 13.
25. This appliance must be properly grounded. Never plug the power cord into a receptacle that is not grounded adequately and in accordance with local and national codes. Refer to installation instructions for grounding this appliance.
26. Ensure pockets are free from small irregularly shaped hard objects and foreign material, such as coins, knives, and pins. These objects could damage your dryer.
27. Do not use heat to dry articles containing foam rubber or similarly textured rubber-like materials.

WARNING: TO REDUCE THE RISK OF FIRE OR EXPLOSION

- Do not dry items that have been previously cleaned, washed, soaked, or spotted with gasoline, dry cleaning solvents, or other flammable or explosive substances. They emit vapors that could ignite or explode. Any material that has been in contact with a cleaning solvent or flammable liquids or solids should not be placed in the dryer until all traces of these

flammable liquids or solids and their fumes have been removed.

- There are many highly flammable items used in homes, such as acetone, denatured alcohol, gasoline, kerosene, some liquid household cleaners, some spot removers, turpentine, waxes, and wax removers.
- Do not dry items containing foam rubber (may be labeled latex foam) or similarly textured rubber-like materials on a heat setting. Heated foam rubber materials can, under certain circumstances, produce fire by spontaneous combustion.

CAUTION

- Do not sit on top of the dryer.
- Because of continuing product improvements, Element Electronics reserves the right of change specifications without notice. For complete details, see the Installation Instructions packed with your product before selecting cabinetry, making cutouts, or beginning installation.
- Do not dry clothing with large buckles, buttons, or other heavy metal or solid things.
- Install and use in accordance with the manufacturer's instructions.
- Do not place items in your dryer that have been spotted or soaked with vegetable oil or cooking oil. Even after being washed, these items may contain significant amounts of these oils.

- Residual oil on clothing can ignite spontaneously. The potential for spontaneous combustion increases when items containing vegetable oil or cooking oil are exposed to heat. A heat source such as your dryer can warm these items, allowing an oxidation reaction in the oil to occur.
- Oxidation creates heat. If this heat cannot escape, the items can become hot enough to catch fire. Piling, stacking, or storing these kinds of items may prevent heat from escaping and can create a fire hazard.
- Take care that children's fingers are not caught in the door when closing it. This may result in injury.
- Gas leaks may occur in your system, resulting in a dangerous situation.
- Gas leaks may not be detected by smell alone.
- Gas suppliers recommend you purchase and install a UL-approved gas detector.

SAVE THESE INSTRUCTIONS

THIS APPLIANCE IS FOR HOUSEHOLD USE ONLY

SPECIFICATIONS

ELECTRIC DRYER (ETDE6727CW)

- Dimensions (H x W x D): 41.7 in. x 27 x 30 in. (105.9 x 68.6 x 76.3 cm)
- Net weight: 121 lbs. (55 kg)
- Gross weight: 137 lbs. (62 kg)
- Capacity: 6.7 ft.³ (.19 m³)
- Rated voltage: 120/240 V
- Rated frequency: 60 Hz

GAS DRYER (ETDG6727CW)

- Dimensions (H x W x D): 41.7 in. x 27 x 30 in. (105.9 x 68.6 x 76.3 cm)
- Net weight: 121 lbs. (55 kg)
- Gross weight: 137 lbs. (62 kg)
- Capacity: 6.7 ft.³ (.19 m³)
- Rated voltage: 120/240 V
- Rated frequency: 60 Hz

TROUBLESHOOTING

If your washer has problems, check this table before making a service call.

PROBLEM	SOLUTIONS
The dryer doesn't start.	<ul style="list-style-type: none"> • Make sure that the door is latched shut. • Make sure that the power cord is plugged into a live electrical outlet. • Check the home's circuit breaker and fuses. • Press ▶ Start/Pause again if the door is opened during the cycle.
The dryer doesn't heat.	<ul style="list-style-type: none"> • Check the home's circuit breaker and fuses. • Select a heat setting other than Air Fluff, and make sure the temperature selection is not on "No heat." • On a gas dryer, check that the gas supply is on. • Clean the lint filter and exhaust duct. • Dryer may have moved into the cool-down process of the cycle.

PROBLEM	SOLUTIONS
The dryer doesn't dry.	<ul style="list-style-type: none"> • Check all the solutions under "The dryer doesn't heat." • Be sure the exhaust hood outside the home opens and closes freely. • Check the exhaust system for lint buildup. Ducting should be inspected and cleaned annually. • Use a 4 in. (10.2 cm) rigid metal exhaust duct. • Do not overload. Only place one wash load into the dryer at a time. • Separate heavy items from lightweight items. • Large, bulky items like blankets or comforters may require repositioning to ensure even drying. • Load may be too small to tumble properly. Add a few towels.
The dryer is noisy.	<ul style="list-style-type: none"> • Check the load for objects such as coins, loose buttons, nails, or broken zippers and remove promptly. • It is normal to hear the dryer gas valve or heating element cycle on and off during the drying cycle. • Be sure the dryer is leveled properly as outlined in the installation instruction. • It is normal for the dryer to hum due to the high velocity of air moving through the dryer drum and exhaust system.
Clothes are unevenly dried.	<ul style="list-style-type: none"> • Seams, pockets, and other similarly heavy areas may not be completely dry when the rest of the load has reached the selected dryness level. This is normal. Select the More Dry setting, if desired. • If one heavy item, such as a towel, is dried with something light, such as sheets, it is possible that the heavy item will not be completely dry when the rest of the load has reached the selected dryness level. Dry heavy and lightweight items in separate loads for best results.
Dryer shuts off before the load is dry.	<ul style="list-style-type: none"> • Dryer load is too small. Add more items or a few towels and restart the cycle. • Dryer load is too large. Remove some items and restart the dryer.
The dryer has a bad odor.	<ul style="list-style-type: none"> • Household odors from painting, varnishing, or strong cleaners may enter the dryer with surrounding room air. This is normal as the dryer draws air from the space around it. • When these odors linger in the air, ventilate the room completely before using the dryer.

PROBLEM	SOLUTIONS
Odors remain in clothing.	<ul style="list-style-type: none"> Fabrics containing strong odors should be washed using the desired wash cycle.
Garments are still wrinkled after Wrinkle Prevent.	<ul style="list-style-type: none"> Small loads of one to four items work best. Load fewer garments. Load similar-type garments.
Lint is on clothes.	<ul style="list-style-type: none"> Clean the lint filter before every cycle. Some fabrics, such as fuzzy white cotton towels, produce lint. They should be dried separately from clothes, such as black linen pants, that trap lint. Divide larger loads into smaller loads for drying. Check pockets thoroughly before washing and drying clothes.

ERROR CODES

ERROR CODE	POSSIBLE CAUSE	SOLUTIONS
C9	The PCB failed.	Do not use the dryer. To contact customer support, see “ Customer support ” on page 33.
E4	The humidity sensor failed.	<ul style="list-style-type: none"> The dryer will complete the current operating cycle, but garments may be over-dried. The dryer still works using the Time Cycles. To contact customer support, see “Customer support” on page 33.
E5	The temperature sensor failed.	Do not use the dryer. To contact customer support, see “ Customer support ” on page 33.

CUSTOMER SUPPORT

If you have questions about your washer, our customer support team is ready to help.

- **Online chat:** <https://elementelectronics.com/appliances>
- **Phone:** 888-842-3577
- **Email:** customerservice@elementelectronics.com

LEGAL NOTICES

ELECTRICAL INFORMATION

THIS APPLIANCE MUST BE GROUNDED.

This appliance is fitted with a plug suitable for use in all houses fitted with sockets to current specifications.

If the fitted plug is not suitable for your socket outlets, it should be cut off and carefully disposed of. To avoid a possible shock hazard, do not insert the discarded plug into a socket.

This appliance complies with the following EEC Directives:

2014 / 35/ EU (Low Voltage Directive)

2014 / 30/ EU (EMC Directive).

WARRANTY

Model Names/Numbers Subject to Limited Warranty:

6.7 Cu. Ft. Front-Load Electric Dryer
(ENTD1064EXBW)

6.7 Cu. Ft. Front-Load Gas Dryer
(ENTD1064GXBW)

(the "Products" or "Product" when referencing a singular product herein)

This Product (including any accessories included in the original packaging) as supplied and distributed in new condition, is warranted by Element Appliance Company, LLC ("Element") to the original customer who purchases the Product from an authorized Element retailer (the "Original Customer" or "you") against defects in material and workmanship under proper use, maintenance, and care according to the owner's manual, warnings, and instructions accompanying the Product ("Warranty") as follows:

* **PLEASE NOTE** – Proof of purchase evidencing the date of purchase by the Original Purchaser from an authorized Element retailer ("Valid Proof of Purchase") is **required** for all Warranty service. The

CORRECT DISPOSAL OF THIS PRODUCT

Old appliances still have some residual value. An environmentally friendly method of disposal will ensure that valuable raw materials can be recovered and used again.



This marking indicates that this product should not be disposed with other household wastes throughout the US. To prevent possible harm to the environment or human health from uncontrolled waste disposal, recycle it responsibly to promote the sustainable reuse of material resources. To return your used device, please use the return and collection systems or contact the retailer where the product was purchased. They can take this product for environmentally safe recycling.

express Warranty set forth herein is subject to all terms and conditions set forth below.

1. WARRANTY SERVICE:

A. ONE-YEAR WARRANTY: Except as provided in subpart 1.B below, for a period of **one (1) year** from the date of purchase by the Original Customer (the "Warranty Period"), if the parts or components covered by this Warranty are determined by Element or Element's authorized service provider to be defective in material or workmanship, Element will, at its sole and absolute discretion and option: (i) repair the defective part or component at no charge to the Original Customer, (ii) replace the defective Product with a new Product of similar or better quality, at no charge to the Original Customer, or (iii) refund the documented purchase price paid by the Original Customer (excluding tax) to the Original Customer upon return of the defective Product as directed by Element. After the Warranty Period expires, the Original Customer must pay for all parts,

components, shipping and handling, labor, and replacement costs associated with the Product or any part or component thereof, regardless of any defects in the Product or any part or component thereof.

B. LIMITED EXTENDED WARRANTY THROUGH PRODUCT REGISTRATION: If and only if the Original Customer registers the Product at www.elementelectronics.com within **ninety (90)** days of the date of purchase by the Original Customer, then the Warranty Period discussed in subpart 1.A. above shall be extended an additional one (1) year to a new Warranty Period equaling **two (2) years** from the date of purchase by the Original Customer. If the Product is not registered as provided for in this subpart 1.B, then the standard one-year Warranty Period set forth in subpart 1.A shall apply.

C. TIMING AND PROCEDURE: Before Warranty service can commence, the Original Customer must contact either (i) the retailer from whom the Original Customer purchased the Product, or (ii) Element directly, in either case for problem determination and service procedures. Valid Proof of Purchase evidencing that the Product is within the Warranty Period **MUST** be presented by Original Customer in order to obtain the requested Warranty service. Please have your model and serial number available, along with your date of purchase of the Product. To remain eligible for Warranty service, Original Customer may not return the Product or any part or component thereof to the retailer or Element without Element's prior written consent.

2. EXCLUSIONS AND LIMITATIONS TO WARRANTY SERVICE

The Warranty covers manufacturing defects in materials and workmanship of the Product encountered in the normal, non-commercial use of the Product, and **does not cover** (a) damages or malfunctions resulting from improper or unreasonable use or maintenance, abuse, negligence, failure to follow instructions contained in any written materials that accompany the Product, deterioration by reason

of excess moisture, corrosive atmosphere, lightning, power surges, connections to improper voltage supply, unauthorized alteration, or other external causes such as extremes in temperature or humidity, modifications, scratches or discoloration; (b) improper or incorrectly performed repairs by service providers not authorized by Element; (c) transportation, shipping, delivery, pickup, insurance, installation, or set-up costs; (d) ordinary wear and tear, cosmetic damage, or damage due to acts of nature, including but not limited to, water, floods, wind, storm, tornado, earthquake, or fire, or due to damage caused by extraordinary impact events, such as dropping, crushing, demolition or other extraordinary damage; (e) commercial use of the Product, or use of the Product for anything other than single-family household or residential use; or (f) modification of the Product or any part of the Product.

This Warranty is made to the Original Customer only and does not cover Products sold AS IS or WITH ALL FAULTS. The Warranty is invalid if the factory-applied serial number has been altered or removed from the Product. This Warranty is valid only in the United States, and only applies to Product if it was purchased and serviced in the United States. The addition of equipment or features to the Product that are not manufactured or recommended by Element could affect the intended function of the Product, and therefore may void the Warranty. Furthermore, the exposure of the Product to chemicals, heat, cold, humidity, or other elements can affect the Product components, and therefore, the Warranty does not cover discoloration, fading, cosmetic changes, rust, or any damages or failure related to any such items. The Warranty is contingent upon the proper use, maintenance, and care of the Product. The Warranty may be void if the Product has been used in a manner contradictory to, or in violation of, the terms of the user's manual, warnings, or instructions accompanying the Product.

THIS WARRANTY IS MADE IN LIEU OF AND SUPERSEDES ALL OTHER WARRANTIES OR

CONDITIONS OF MERCHANTABILITY OR FITNESS FOR A PARTICULAR PURPOSE OR GENERAL USE, WHETHER EXPRESS, IMPLIED, COLLATERAL, STATUTORY, OR PROVIDED BY COMMON LAW, THE UNIFORM COMMERCIAL CODE, OR OTHERWISE. ELEMENT FURTHER DISCLAIMS ALL WARRANTIES AFTER THE END OF THE WARRANTY TERM DEFINED ABOVE. NO OTHER EXPRESS WARRANTY OR GUARANTY GIVEN BY ANY OTHER PERSON, FIRM, OR ENTITY WITH RESPECT TO THE PRODUCT SHALL BE BINDING ON ELEMENT. REPAIR, REPLACEMENT, OR REFUND OF THE ORIGINAL PURCHASE PRICE, AT ELEMENT'S SOLE DISCRETION, ARE THE EXCLUSIVE REMEDIES OF THE CUSTOMER.

ELEMENT SHALL NOT BE LIABLE FOR ANY INCIDENTAL OR CONSEQUENTIAL DAMAGES CAUSED BY THE USE, MISUSE, OR INABILITY TO USE THE PRODUCT. THESE INCLUDE, BUT ARE NOT LIMITED TO, ANY DAMAGES IN THE FORM OF LOST PROFITS, LOSS OF USE, LEGAL FEES, ECONOMIC LOSS, PERSONAL INJURIES, OR ANY OTHER DAMAGES CAUSED BY CIRCUMSTANCES BEYOND THE CONTROL OF ELEMENT. NOTWITHSTANDING THE FOREGOING, ELEMENT'S AGGREGATE LIABILITY TO ANY CUSTOMER SHALL NOT EXCEED THE ORIGINAL PURCHASE PRICE OF THE PRODUCT. THIS WARRANTY SHALL NOT EXTEND TO ANYONE OTHER THAN THE ORIGINAL CUSTOMER WHO PURCHASED THE PRODUCT, AND IS NOT TRANSFERRABLE. NO PERSON IS AUTHORIZED TO ALTER, EXTEND, OR WAIVE THIS WARRANTY OR ANY OF ITS TERMS OR CONDITIONS.

Some states do not allow the exclusion or limitation of incidental or consequential damages, or allow limitations on warranties, so the above limitations or exclusions may not apply to you. This Warranty gives you specific rights, and you may have other rights, which vary from state to state. The exclusions and limitations to the Warranty apply to the maximum extent permitted by law and unless restricted or prohibited by law. Where any term of this

Warranty is prohibited by applicable law, it shall be null and void, but the remainder of this Warranty shall remain in effect.

PLEASE CONTACT THE RETAILER FROM WHOM YOU PURCHASED THE PRODUCT FOR CUSTOMER SERVICE OR TO CONFIRM PROCEDURES FOR WARRANTY SERVICE.

In the event you wish to contact Element, please direct all correspondence to:

Element Appliance Company, LLC

customerservice@elementelectronics.com

888-842-3577

<https://elementelectronics.com/appliances>



Element, the Element Logo, and Bring it home are trademarks of Element Brand Holding, LLC. All other trademarks are the property of their respective owner, who has not sponsored, endorsed, or approved this product. ©2023 Element Appliance Company, LLC. All rights reserved.

Distributed by Element Appliance Company, LLC
Augusta, GA 30909

For service, support and warranty information:
Call 888.842.3577, email us at
customerservice@elementelectronics.com
or visit www.elementelectronics.com